



R-MAG-M Magnetic Clamping System for Sheet Metal Forming
Operating temperature up to 100 °C



Advantages

- **QUICK** – Dies are clamped in one second at the touch of a button
- **PROFITABLE** – Setup cost optimisation from die change that takes only a few minutes
- **FLEXIBLE** – Die standardization no longer required
- **ERGONOMIC** – Safe die handling with ease
- **RELIABLE** – Distortion-free and full-surface retention force even if power fails
- **SAFE** – Various sensors monitor the entire clamping cycle

OUR HIGHLIGHTS

- Long pole technology with:**
- Extremely high clamping forces
 - Clamping force display
 - Interchangeable magnetic poles (without grinding)
 - All-metal surface

Application

R-MAG-M magnetic clamping systems are used primarily for the automatic clamping of different dies on sheet metal forming presses and automatic punching machines.

Description

With magnetic clamping systems, the moulds are magnetically clamped or unclamped at the push of a button within a few seconds.

Since permanent magnets generate the force of the magnetic clamping plates, electric clamping is only required to magnetize the plates.

The magnetic clamping plates are de-energized in clamped condition and thus absolutely safe in case of power failure.

Additionally, the complete clamping cycle is monitored by different sensors, thus guaranteeing reliable die clamping.

Scope of system and delivery

R-MAG-M magnetic clamping systems are delivered as complete clamping systems with all required system components. The essential components of a system are:

- two magnetic clamping plates
- electric control in a splash-proof control box
- modern 8" colour touch panel
- required electrical connection cables

Customised versions

All R-MAG magnetic clamping systems are customized and manufactured to meet specific requirements.



For example, the size and pole technology of the magnetic clamping plates are selected according to the application and the machine.

Please contact us.

High safety standard thanks to:

- Inductive position monitoring of the die contact (switching distance 0.2 mm, adjustable)
- Redundant system with additional "flux sensor"
- Even the smallest die movements are monitored and reported
- Monitoring of correct magnetisation/power contacts
- Permanent temperature monitoring in the plate (overload protection)
- Standard interface according to EN 201/289 and Euromap

Technical Data

Surface of the magnetic plate		Metallic, smooth and sturdy
Size of the magnetic clamping plates		Customised
Pole technology		Long pole and square pole
Plate thickness		
Long pole 	[mm]	55
Square pole 	[mm]	38 or 55
Max. temperature	[°C]	100
Magnetic retention force (per pole)		
Long pole 232 x 68 mm	[kN]	21 (2100 kg)
Square pole 55 x 55 mm	[kN]	2 (200 kg)
Magnetic penetration depth	[mm]	20

Installation on a sheet metal forming press

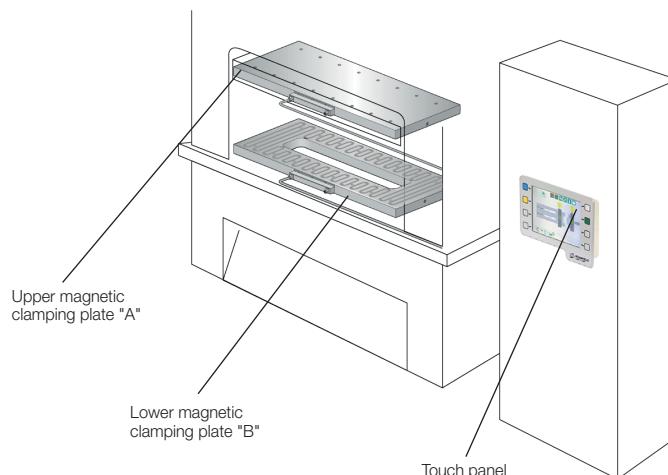

Function of the magnetic clamping plates

The electro-permanent magnetic clamping system is also firmly kept in place if the power fails. Power is only required for approx. 1 to 2 seconds to magnetize the system. After that, the clamping system works independently of any power supply. The magnetic clamping force is exclusively generated by the permanent magnets. Only when the mould is unclamped is electrical energy required again (1–2 seconds) to demagnetize the clamping plate. An existing AlNiCo magnet in the core is re-polarized by a current pulse. This magnet affects the magnetic field and relocates it completely to the interior of the magnetic clamping plate (demagnetized) or approx. 20 mm outside the plate (magnetized).

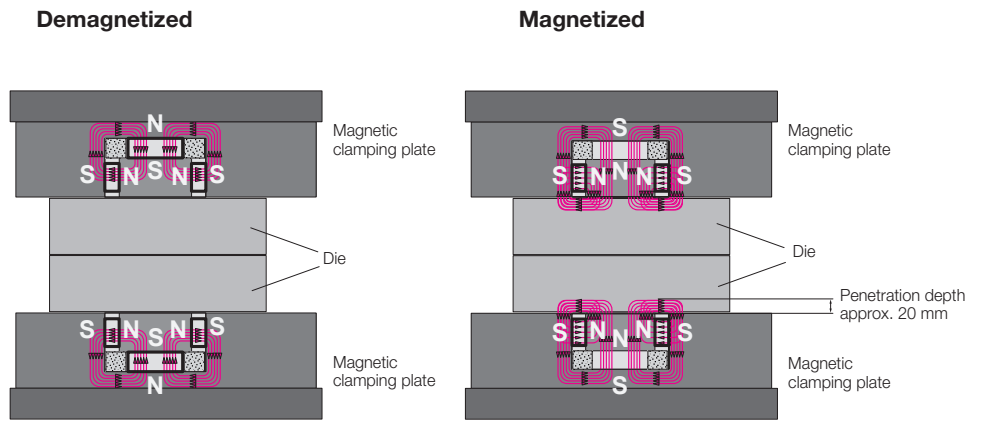

Available as an option:

- Control of external roller or ball bars
- Log files and all parameters stored on SD card
- Remote access via VPN, Ethernet, CAN-BUS, or RS485 protocol
- Higher operating temperature up to 230 °C
- When using R-MAG long poles:
 - With clamping force display (flux sensors in the plate)
 - Replaceable magnetic poles (without grinding)

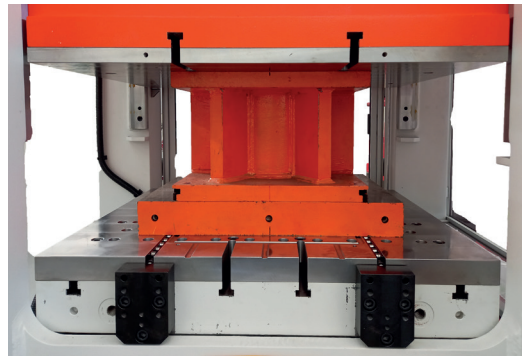

R-MAG long pole technology



R-MAG square pole technology

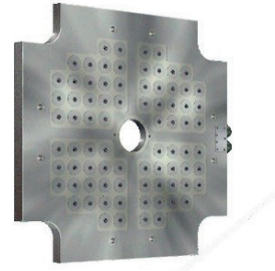

Replacement of long poles

The long poles are pre-assembled and pluggable, allowing for easy replacement of the magnetic poles on site. Römheld offers you the option of replacing a (single) defective magnetic pole on site. This reduces system downtime.

User-friendly R-MAG control and touch panel

The 8-inch touchscreen is easy to read, sturdy and ideally suited for use on machines and systems. The housing has a LAN connection and/or an SD card slot. The display shows the status of the device and the available functions. The current clamping situation is always indicated and changes colour depending on the system status: red for important alarms and messages, orange/yellow for secondary problems, green for validation, and grey for basic functions.

Multiple access levels allow for different permissions for the operator. To ensure safety and traceability of use, a unique operator ID and password are created.

The remote access function uses a VNC protocol. This enables remote diagnosis by our ROEMHELD engineers. Even if the touchscreen is defective, all functions are available on the service screen. This allows for remote troubleshooting or a system reset before on-site re-

pair is necessary. The operator at the machine must confirm these processes. The buttons remain functional even if the touchscreen display is defective.



Wedge clamping elements in hydraulic or electric versions

Data sheet WZ 2.2450



Data sheet WZ 2.2451

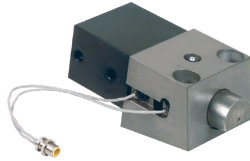

Data sheet WZ 5.2670

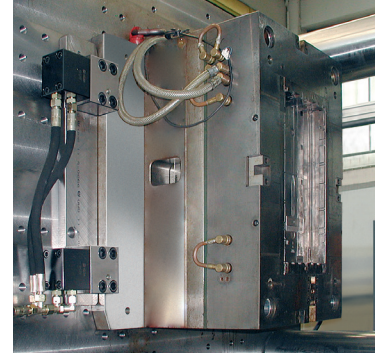

Roller or ball bars

Roller and ball bars in the lower magnetic clamping plate allow easy and trouble-free die change and prevent damages to the surface.

Data sheets WZ 8.18340 – 8.18347

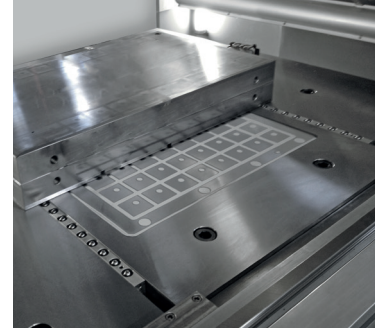
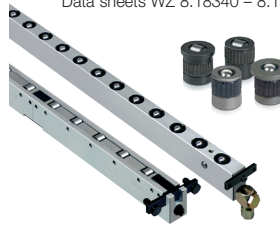

See roller and ball bar configurator:
<https://www.roemheld-gruppe.de/productconfigurator/?lang=en>

Driven die changing systems

Data sheet WZ 8.18362



Combination of push chain direct system with standard carrying console

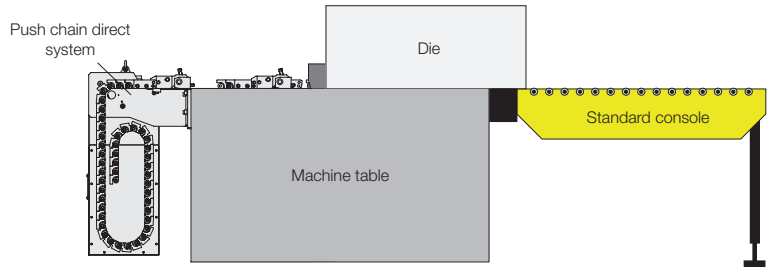

Die changing carts and carrying consoles

Data sheet WZ 8.8900



Data sheet WZ 8.8904

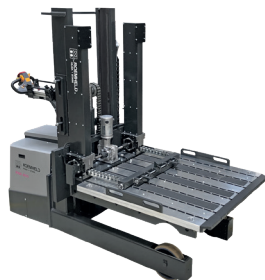

Data sheets WZ 8.18350 – 8.18354

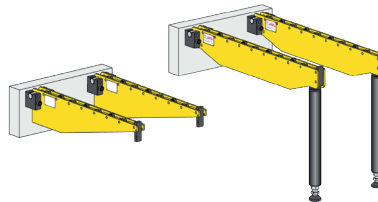

Discover the QDC app now!

<https://wz-app.roemheld.de/en/home>



Magnetic clamping systems also available for:

- Sheet metal forming
- Plastics industry
- Rubber moulding presses
- Mould carriers
- Die casting machines