



## Wedge Clamps for Tapered Clamping Edge

double acting, max. clamping force 25 to 630 kN (1250 kN\*)  
 without and with position monitoring at the side



### Advantages

- Safe clamping of moulds/dies with tapered clamping edge
- High operational safety by position monitoring and automatic motion sequence
- Very sturdy design
- Long service life
- Sizes up to 1250 kN are available on request

### Important notes

In case of incorrect operation of the wedge clamps, the clamping bolt may fully retract into the guide housing and thus cause the upper mould/die falling off the ram.

The greasing intervals (high temperature grease) should be adapted to the existing operating conditions. Please note that greasing of the wedge bolt should only be made with the elements being retracted.

The clamping elements must be protected against dirt, scale, swarf, coolant, etc. by means of a suitable covering.

Moulds or dies clamped by means of wedge clamps are subject to side loads that may be strong enough to displace them. Thus, positioning is required to absorb the side loads. Therefore, location pins or suitable limit stops should be provided to keep the moulds and dies in their correct position.

When using wedge clamps on the press ram, it is recommended that multiple-circuit hydraulic supply of the clamping elements and pilot-controlled check valves are used for securing hydraulic clamping.

### Circuit diagram

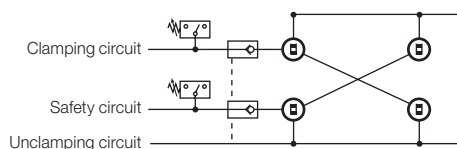

For safety reasons and in the sense of the machine tool guide lines ML2006/42/EC the hydraulic pressure must be maintained.

When upper moulds/dies are clamped by wedge clamps, they must be secured mechanically when maintenance work is carried out.

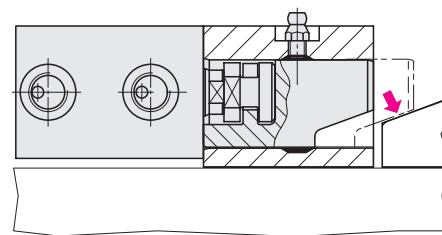

### Versions

- without position monitoring  
max. temperature: 160 °C  
(300 °C on request)
- with position monitoring at the side  
max. temperature: 100 °C

### Position monitoring

The integrated position monitoring is coupled to the clamping bolt in a very space-saving way at the side and signals:

1. Clamping bolt in unclamping position
2. Clamping bolt in clamping position
3. Error message when overrunning the clamping position

### Clamping force

This is the force the clamping element applies to the mould or die. The mould or die is clamped on the fixture plate by means of this force. The external forces acting on mould or die (e.g. ejecting force or die cushion force) shall not exceed the totality of the elements' clamping force.

### Maximum admissible operating force

This is the force that can be absorbed by the clamping element and the fastener (screws). It must be ensured that in cases of emergency, e.g. workpiece jammed in mould or die, the sum total of the elements' operating forces is not exceeded.

### Application example

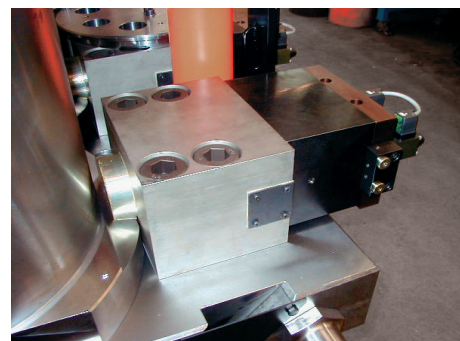

Wedge clamps on a forging press

### Application

Double-acting wedge clamp for clamping moulds or dies on a press bed or ram or in injection moulding machines, machines and installations.

### Description

The wedge clamp consists of a hydraulic block cylinder and a piston guided in a housing. The clamping bolt is provided with 20° bevel to clamp on the tapered clamping surface of the mould/die.

Based on the internal design of the wedge clamp and the 20° bevel of the clamping bolt, the system is providing internal friction.

### Retrofitting to wedge clamping

see page 4

\* Sizes up to 1250 kN are available on request

# Wedge Clamps without position monitoring

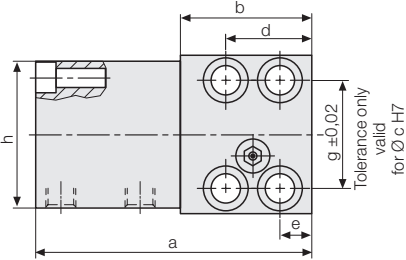
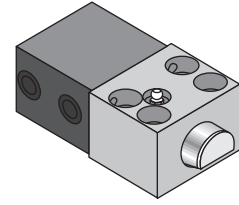
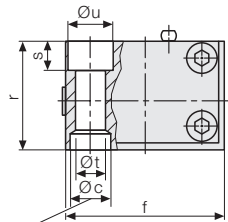
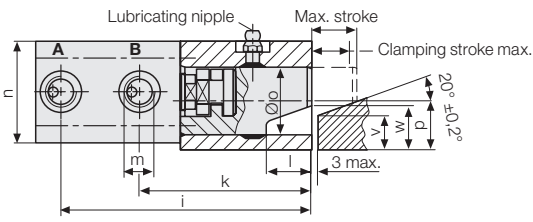

### Installation of drill bushings to absorb side loads

The occurring side loads must be absorbed by drill bushings to be inserted into the fixture plate.

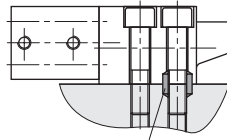

Accessories:  
Drill bushings

### Technical data

Temperature resistance up to 160 °C

Clamping force max.	[kN]	25**	50	100	160	250	400	630*
Max. admissible operating force Screw DIN 912 8.8	[kN]	35	65	130	210	320	520	820
<b>Max. operating pressure</b>	<b>[bar]</b>	<b>350</b>	<b>275</b>	<b>350</b>	<b>350</b>	<b>350</b>	<b>350</b>	<b>350</b>
Cylinder Ø	[mm]	25	40	50	63	80	100	125
Max. stroke	[mm]	20	25	25	30	32	40	40
Clamping stroke (from/to)	[mm]	15 – 18	18 – 22	19 – 22	23 – 27	24 – 29	30 – 36	30 – 36
Max. oil consumption	[mm]	10	31	49	94	161	314	491
a	[mm]	122	157	190	227	267	310	375
b	[mm]	58	78	100	125	150	180	225
Ø c H7 x depth	[mm]	18/7	26/9	30/11	35/11	48/13	55/16	62/16
d	[mm]	38	46	58	75	78	95	108
e	[mm]	14	16	20	25	26	32	38
f	[mm]	70	95	120	150	200	240	280
g	[mm]	48	65	85	106	140	180	210
h	[mm]	65	85	100	125	160	200	230
i	[mm]	111	146	177	210	246	285	344
k	[mm]	76	102	127	151	184	215	272
l	[mm]	20	25	26	32	40	45	50
m		G 1/4	G 1/4	G 1/4	G 1/2	G 1/2	G 1/2	G 1/2
n	[mm]	45	63	75	95	120	150	180
Ø o	[mm]	30	40	55	70	80	100	125
p	[mm]	21.5	28	37	49	55	75	85
r	[mm]	48	65	80	105	125	160	190
s	[mm]	13	18	20	26	32	38	44
Ø t	[mm]	13	17	21	26	33	39	45
Ø u	[mm]	20	26	32	40	48	57	66
v	[mm]	15	18	25	30	30	50	60
w	[mm]	19.5	23.5	30.5	37	38	60	70
Screw DIN 912-8.8 (4 off)		M 12	M 16	M 20	M 24	M 30	M 36	M 42
Tightening torque	[Nm]	86	210	410	710	1450	2520	4050
Weight	[kg]	2.4	5.8	10.6	21	40	74	125
<b>Part no.</b>		<b>4604620</b>	<b>4604621</b>	<b>4604622</b>	<b>4604623</b>	<b>4604634</b>	<b>4604635</b>	<b>4604636</b>

### Accessories

Drill bushings DIN 179	[mm]	12 x 12	17 x 16	21 x 20	26 x 20	32 x 25	38 x 30	44 x 30
<b>Part no.</b>		<b>3300285</b>	<b>3300287</b>	<b>3300288</b>	<b>3300289</b>	<b>3300420</b>	<b>3300430</b>	<b>3300440</b>

\* sizes up to 1250 kN are available on request

\*\* lubricating nipples of the version with a clamping force of 25 kN are offset by 9.5 mm and protrude by 5 mm

# Wedge Clamps with position monitoring at the side

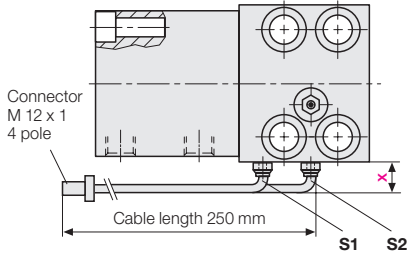
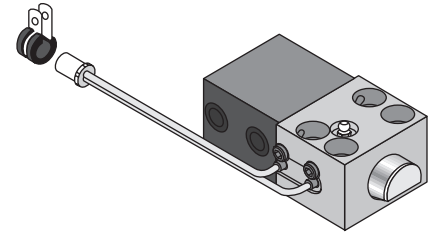
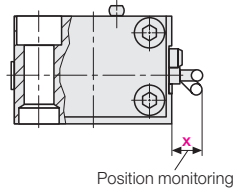
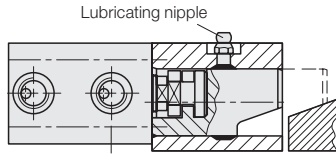

### Description

The proximity switches are installed in the guide housing. They are activated by means of the wedge bolt. The positions of the bolt in off-position or in clamping position are displayed.

**S1:** Clamping bolt in unclamping position

**S2:** Clamping bolt in clamping position

**S2 is overrun:** Clamping bolt in final position (message for no mould/die available or mould/die not clamped)

Special versions with signal up to final bolt position are available on request.

### Technical data

Temperature resistance up to 100 °C

Clamping force max. [kN]	25*	50	100	160	250	400	630
x Position monitoring [mm]	12	5	0	0	0	0	0
Part no.	824030500	824040500	824050500	824060500	824070500	824080500	824090500

\* lubricating nipples of the version with a clamping force of 25 kN are offset by 9.5 mm and protrude by 5 mm

### Accessories

#### Connecting cable with screw coupling

Cable length 5 m **Part no. 5700013**

Cable length 10 m **Part no. 5700014**

#### Pin assignment 4-pole

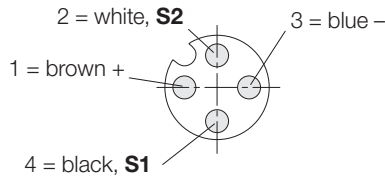

### Principle of die or mould clamping

In general, moulds/dies with round geometry are clamped by using three clamping elements for each half, whereas mould/dies with square geometry are clamped by using four clamping elements for each half (see figure).

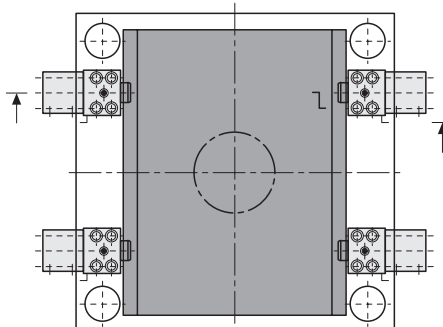
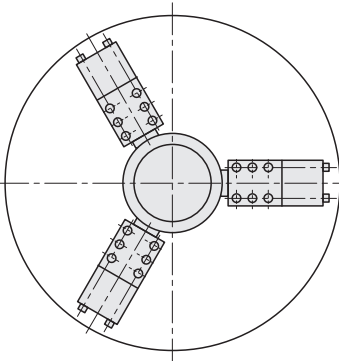
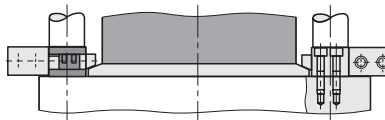
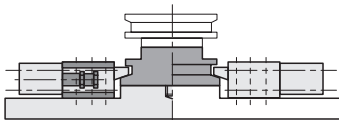

## Accessories V-shaped inserts

### Retrofitting to wedge clamping

Retrofitting existing tools for wedge clamping can be simplified by using the V-shaped inserts shown below.

The wedge inserts also protect the tool surface from wear and compensate for soft material.

Max. hardness 50 HRC

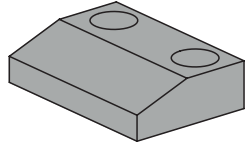

### Dimensions

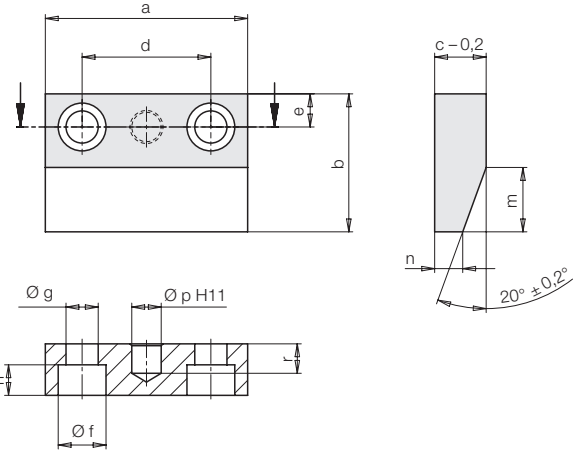

Hardened V-shaped insert

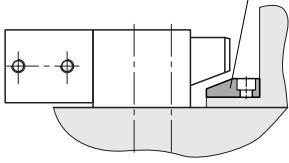

without position monitoring		4604620 4604621	4604622	4604623	4604634	4604635	4604636
with position monitoring		824030500 824040500	824050500	824060500	824070500	824080500	824090500
a	[mm]	50	65	80	90	110	130
b	[mm]	40	45	55	60	75	75
c	[mm]	15	17	20	20	28	28
d	[mm]	30	40	50	60	70	90
e	[mm]	10	12	15	15	18	20
f	[mm]	15	18	20	20	26	26
g	[mm]	9	11	13.5	13.5	17.5	17.5
h	[mm]	8.6	10.6	12.6	12.6	16.6	16.6
m	[mm]	20	20	25	30	35	35
n	[mm]	7.7	9.7	10.9	9.1	15.3	15.3
p	[mm]	8	10	12	12	16	16
r	[mm]	10	10	12	12	16	16
<b>V-shaped inserts</b>	<b>Part no.</b>	<b>510280166</b>	<b>510280173</b>	<b>510280174</b>	<b>510280175</b>	<b>510280176</b>	<b>510280177</b>