



ROEMHELD
HILMA ■ STARK

CATALOGUE

R-MAG Magnetic Clamping Systems



**For every application
a suitable solution:**

Sheet metal forming

Injection moulding
machines

Rubber molding presses

Mould carriers and
special applications

Die casting machines

ws.roemheld.com

wz.roemheld.com

mh.roemheld.com



**Discover the
QDC app now!**

<https://wz-app.roemheld.de/en/home>



www.roemheld.com



Advantages of Die Clamping Systems

Why die clamping systems?

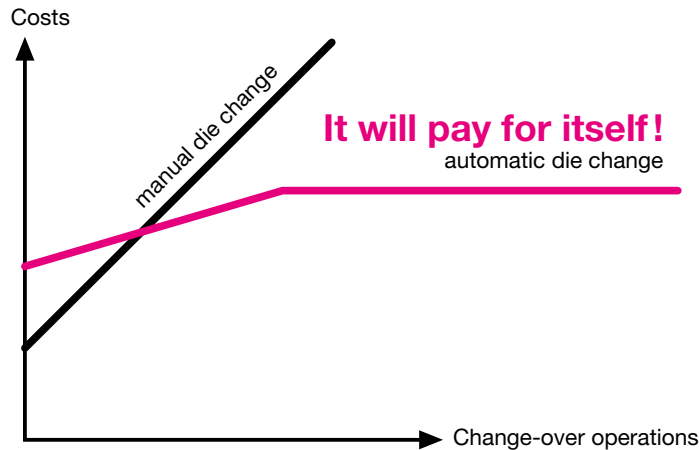

Innovative technology and many years of experience are the basis for our range of die clamping and changing systems.

Rationalise your operation by using automatic die changing systems.

Increased productivity

- more capacity thanks to reduced set-up times
- less downtime, e.g. due to tool breakage or reworking the die
- short test period

Automation

- power-operated elements
- monitoring elements, in particular for pressure and position
- short cycles thanks to automatic triggering of functions
- integration with process monitoring and control

Increase in quality

- consistent quality
- repeatability of die position
- low-distorsion clamping

Operating facility

- operate under extreme circumstances (high temperature, spray)
- clamping in barely accessible positions without any problems
- clamping using high clamping forces
- dies may be changed by relatively unskilled workers
- repeatable die change process

Efficiency

- short set-up times even for small batches, smaller stock of parts
- simplified die change, also for the machine operator
- fewer jigs and fixtures required
- enhanced tool life as a result of less wear
- reduced run-in period for moulds and dies, i.e. fewer test pieces and less time required

Reduced rate of wear

- uniform and low-distortion clamping with high clamping forces
- compensating clamping force (elasticity)
- repeatable positioning and clamping process
- optimum selection of clamping points



R-MAG
Magnetic Clamping Systems

Magnetic Clamping Technology



9.1132

**Magnetic Clamping Systems
for Sheet Metal Forming
R-MAG-M**

operating temperature
up to 100°C



9.1134

**Magnetic Clamping Systems
for Injection Moulding Machines
R-MAG-P**

operating temperature
up to 150°C



9.1136

**Magnetic Clamping Systems
for Rubber Moulding Presses
R-MAG-R**

operating temperature
up to 230°C



9.1138

**Magnetic Clamping Systems
for Mould Carriers
and Special Applications
R-MAG-F**

operating temperature
up to 100°C



9.1140

**Magnetic Clamping Systems
for Die Casting Machines
R-MAG-D**

operating temperature
up to 200°C



**Accessories and Alternative
Clamping Technology
for R-MAG Magnetic Clamping
Systems**

R-MAG-M Magnetic Clamping System for Sheet Metal Forming

Operating temperature up to 100 °C



Advantages

- **QUICK** – Dies are clamped in one second at the touch of a button
- **PROFITABLE** – Setup cost optimisation from die change that takes only a few minutes
- **FLEXIBLE** – Die standardization no longer required
- **ERGONOMIC** – Safe die handling with ease
- **RELIABLE** – Distortion-free and full-surface retention force even if power fails
- **SAFE** – Various sensors monitor the entire clamping cycle

OUR HIGHLIGHTS

Long pole technology with:

- Extremely high clamping forces
- Clamping force display
- Interchangeable magnetic poles (without grinding)
- All-metal surface

Application

R-MAG-M magnetic clamping systems are used primarily for the automatic clamping of different dies on sheet metal forming presses and automatic punching machines.

Description

With magnetic clamping systems, the moulds are magnetically clamped or unclamped at the push of a button within a few seconds.

Since permanent magnets generate the force of the magnetic clamping plates, electric clamping is only required to magnetize the plates.

The magnetic clamping plates are de-energized in clamped condition and thus absolutely safe in case of power failure.

Additionally, the complete clamping cycle is monitored by different sensors, thus guaranteeing reliable die clamping.

Scope of system and delivery

R-MAG-M magnetic clamping systems are delivered as complete clamping systems with all required system components. The essential components of a system are:

- two magnetic clamping plates
- electric control in a splash-proof control box
- modern 8" colour touch panel
- required electrical connection cables

Customised versions

All R-MAG magnetic clamping systems are customized and manufactured to meet specific requirements.

For example, the size and pole technology of the magnetic clamping plates are selected according to the application and the machine. Please contact us.

High safety standard thanks to:

- Inductive position monitoring of the die contact (switching distance 0.2 mm, adjustable)
- Redundant system with additional "flux sensor"
- Even the smallest die movements are monitored and reported
- Monitoring of correct magnetisation/power contacts
- Permanent temperature monitoring in the plate (overload protection)
- Standard interface according to EN 201/289 and Euromap

Technical Data

| | | |
|--------------------------------------|--------------------------|-----------------------------|
| Surface of the magnetic plate | | Metallic, smooth and sturdy |
| Size of the magnetic clamping plates | | Customised |
| Pole technology | | Long pole and square pole |
| Plate thickness | | |
| Long pole | <input type="checkbox"/> | [mm] 55 |
| Square pole | <input type="checkbox"/> | [mm] 38 or 55 |
| Max. temperature | | [°C] 100 |
| Magnetic retention force (per pole) | | |
| Long pole | 232 × 68 mm | [kN] 21 (2100 kg) |
| Square pole | 55 × 55 mm | [kN] 2 (200 kg) |
| Magnetic penetration depth | | [mm] 20 |

Installation on a sheet metal forming press

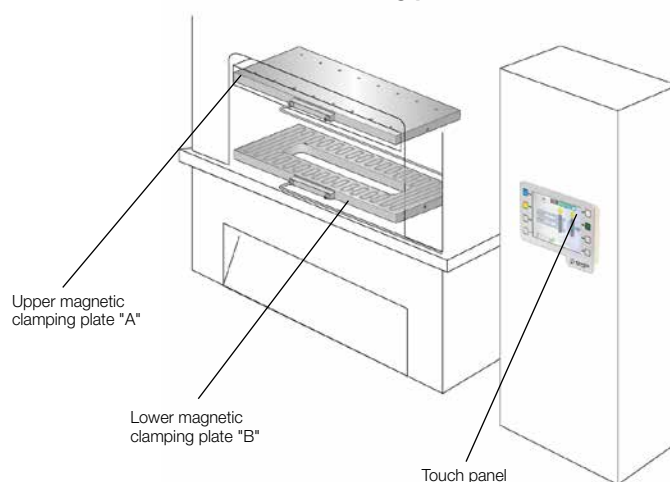

Function of the magnetic clamping plates

The electro-permanent magnetic clamping system is also firmly kept in place if the power fails. Power is only required for approx. 1 to 2 seconds to magnetize the system. After that, the clamping system works independently of any power supply. The magnetic clamping force is exclusively generated by the permanent magnets. Only when the mould is unclamped is electrical energy required again (1–2 seconds) to demagnetize the clamping plate. An existing AlNiCo magnet in the core is re-polarized by a current pulse. This magnet affects the magnetic field and relocates it completely to the interior of the magnetic clamping plate (demagnetized) or approx. 20 mm outside the plate (magnetized).

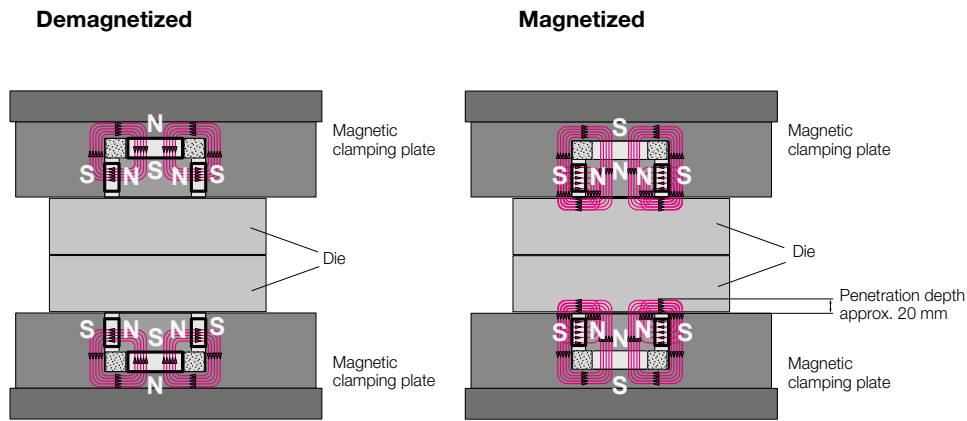

Available as an option:

- Control of external roller or ball bars
- Log files and all parameters stored on SD card
- Remote access via VPN, Ethernet, CAN-BUS, or RS485 protocol
- Higher operating temperature up to 230 °C
- When using R-MAG long poles:
 - With clamping force display (flux sensors in the plate)
 - Replaceable magnetic poles (without grinding)

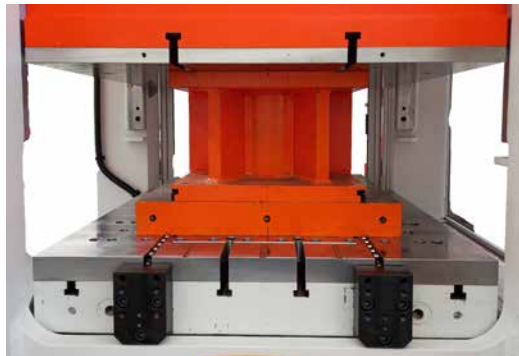

R-MAG long pole technology



R-MAG square pole technology



Replacement of long poles

The long poles are pre-assembled and pluggable, allowing for easy replacement of the magnetic poles on site. Römheld offers you the option of replacing a (single) defective magnetic pole on site. This reduces system downtime.

User-friendly R-MAG control and touch panel

The 8-inch touchscreen is easy to read, sturdy and ideally suited for use on machines and systems. The housing has a LAN connection and/or an SD card slot. The display shows the status of the device and the available functions. The current clamping situation is always indicated and changes colour depending on the system status: red for important alarms and messages, orange/yellow for secondary problems, green for validation, and grey for basic functions.

Multiple access levels allow for different permissions for the operator. To ensure safety and traceability of use, a unique operator ID and password are created.

The remote access function uses a VNC protocol. This enables remote diagnosis by our ROEMHELD engineers. Even if the touchscreen is defective, all functions are available on the service screen. This allows for remote troubleshooting or a system reset before on-site re-

pair is necessary. The operator at the machine must confirm these processes. The buttons remain functional even if the touchscreen display is defective.





R-MAG-P Magnetic Clamping System for Injection Moulding Machines

Operating temperature up to 100 °C (150 °C optional)

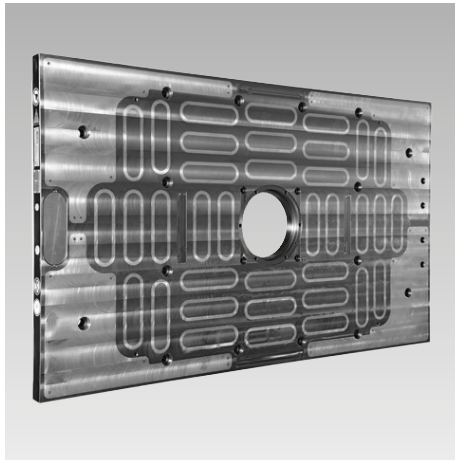

Advantages

- **QUICK** – Dies are clamped in one second at the touch of a button
- **PROFITABLE** – Setup cost optimization from die change that takes only a few minutes
- **FLEXIBLE** – Die standardization no longer required
- **ERGONOMIC** – Safe die handling with ease
- **RELIABLE** – Distortion-free and full-surface retention force even if power fails – with exchangeable poles in long pole technology
- **SAFE** – Various sensors monitor the entire clamping cycle
– with clamping force display in long pole technology

OUR HIGHLIGHTS

Long pole technology with:

- Extremely high clamping forces
- Clamping force display
- Interchangeable magnetic poles (without grinding)
- All-metal surface

Application

R-MAG-P magnetic clamping systems are primarily used for automatic clamping of different moulds on plastic injection moulding machines.

Description

With magnetic clamping systems, the moulds are magnetically clamped or unclamped at the push of a button within a few seconds. Since permanent magnets generate the force of the magnetic clamping plates, electric clamping is only required to magnetize the plates. The magnetic clamping plates are de-energized in clamped condition and thus absolutely safe in case of power failure. Additionally, the complete clamping cycle is monitored by different sensors, thus guaranteeing reliable die clamping.

Scope of system and delivery

- R-MAG-P magnetic clamping systems are delivered as complete clamping systems with all required system components. The essential components of a system are:
- two magnetic clamping plates
 - electric control in a splash-proof control box
 - modern 8" colour touch panel
 - required electrical connection cables

Customised versions

All R-MAG magnetic clamping systems are customized and manufactured to meet specific requirements. For example, the size and pole technology of the magnetic clamping plates are selected according to the application and the machine. Please contact us.

High safety standard thanks to:

- Inductive position monitoring of the die contact (switching distance 0.2 mm, adjustable)
- Redundant system with additional "flux sensor"
- Even the smallest die movements are monitored and reported
- Monitoring of correct magnetisation/power contacts
- Permanent temperature monitoring in the plate (overload protection)
- Standard interface according to EN 201/289 and Euromap

Basic technical data

| | | |
|--------------------------------------|--------------------------|-----------------------------|
| Surface of the magnetic plate | | Metallic, smooth and sturdy |
| Size of the magnetic clamping plates | | Customised |
| Pole technology | | Long pole and square pole |
| Plate thickness | | |
| Long pole | <input type="checkbox"/> | [mm] 55 |
| Square pole | <input type="checkbox"/> | [mm] 38 or 55 |
| Max. temperature | | [°C] 100 (150 optional) |
| Magnetic retention force (per pole) | | |
| Long pole | 232 × 68 mm | [kN] 21 (2100 kg) |
| Square pole | 55 × 55 mm | [kN] 2 (200 kg) |
| Magnetic penetration depth | | [mm] 20 |

Installation on an injection moulding machine

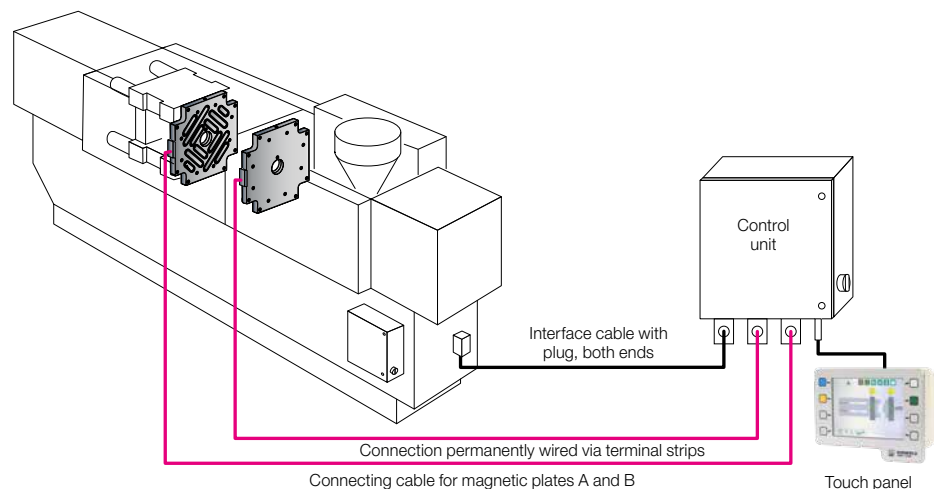

Function of the magnetic clamping plates

The electro-permanent magnetic clamping system is also firmly kept in place if the power fails. Power is only required for approx. 1 to 2 seconds to magnetize the system. After that, the clamping system works independently of any power supply. The magnetic clamping force is exclusively generated by the permanent magnets. Only when the mould is unclamped is electrical energy required again (1–2 seconds) to demagnetize the clamping plate. An existing AlNiCo magnet in the core is re-polarized by a current pulse. This magnet affects the magnetic field and relocates it completely to the interior of the magnetic clamping plate (demagnetized) or approx. 20 mm outside the plate (magnetized).

Demagnetized

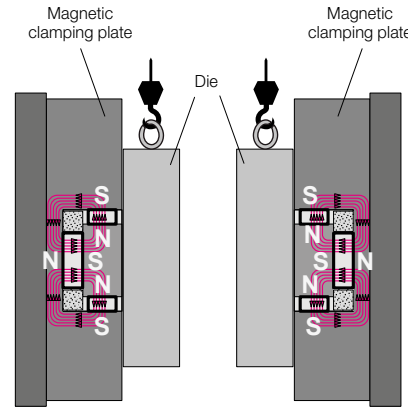

Magnetized

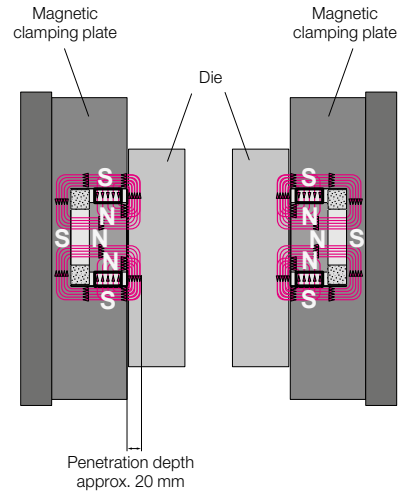

Available as an option:

- Log files and all parameters stored on SD card
- Remote access via VPN, Ethernet, CAN-BUS, or RS485 protocol
- Higher operating temperature up to 230 °C
- When using R-MAG long poles:
 - With clamping force display (flux sensors in the plate)
 - Replaceable magnetic poles (without grinding)



R-MAG-P, with long poles for injection moulding machines

R-MAG long pole technology



Replacement of long poles

The long poles are pre-assembled and plug-gable, allowing for easy replacement of the magnetic poles on site. Römheld offers you the option of replacing a (single) defective magnetic pole on site. This reduces system downtime.

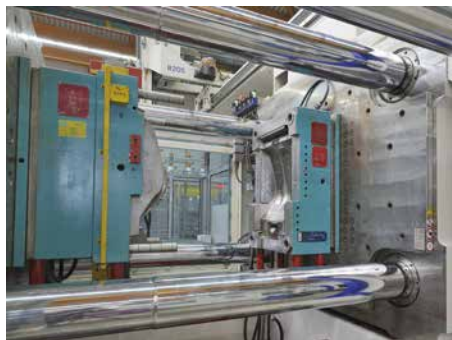

R-MAG-P, with square poles for injection moulding machines up to 300 t

R-MAG square pole technology



User-friendly R-MAG control and touch panel

The 8-inch touchscreen is easy to read, sturdy and ideally suited for use on machines and systems. The housing has a LAN connection and/or an SD card slot. The display shows the status of the device and the available functions. The current clamping situation is always indicated and changes colour depending on the system status: red for important alarms and messages, orange/yellow for secondary problems, green for validation, and grey for basic functions. Multiple access levels allow for different permissions for the operator. To ensure safety and traceability of use, a unique operator ID and password are created.

The remote access function uses a VNC protocol. This enables remote diagnosis by our ROEMHELD engineers. Even if the touchscreen is defective, all functions are available on the service screen. This allows for remote trouble-

shooting or a system reset before on-site repair is necessary. The operator at the machine must confirm these processes. The buttons remain functional even if the touchscreen display is defective.



R-MAG-R Magnetic Clamping System for Rubber Moulding Presses

Operating temperature up to 230°C



Vertical application



Horizontal application

Application

R-MAG-P magnetic clamping systems are primarily used for automatic clamping of different dies on rubber presses.

Description

With magnetic clamping systems, the moulds are magnetically clamped or unclamped at the push of a button within a few seconds.

Since permanent magnets generate the force of the magnetic clamping plates, electric clamping is only required to magnetize the plates.

The magnetic clamping plates are de-energized in clamped condition and thus absolutely safe in case of power failure.

Additionally, the complete clamping cycle is monitored by different sensors, thus guaranteeing reliable die clamping.

Scope of system and delivery

R-MAG-R magnetic clamping systems are delivered as complete clamping systems with all required system components. The essential components of a system are:

- two magnetic clamping plates
- electric control in a splash-proof control box
- A manual remote control
- required electrical connection cables

Customised versions

All R-MAG magnetic clamping systems are customized and manufactured to meet specific requirements.

For example, the size and pole arrangement of the magnetic clamping plates are selected according to the application and the machine. Please contact us.

Technical Data

| | | |
|--------------------------------------|-----------------------|------------|
| Size of the magnetic clamping plates | | Customised |
| Pole technology | | Long pole |
| Max. temperature | [°C] | 230 |
| Effective magnetic force | [kg/cm ²] | 5–12 |
| Magnetic penetration depth | [mm] | 20 |
| Plate thickness | [mm] | min. 55 |

* force directly on the magnet

Installation on a rubber press

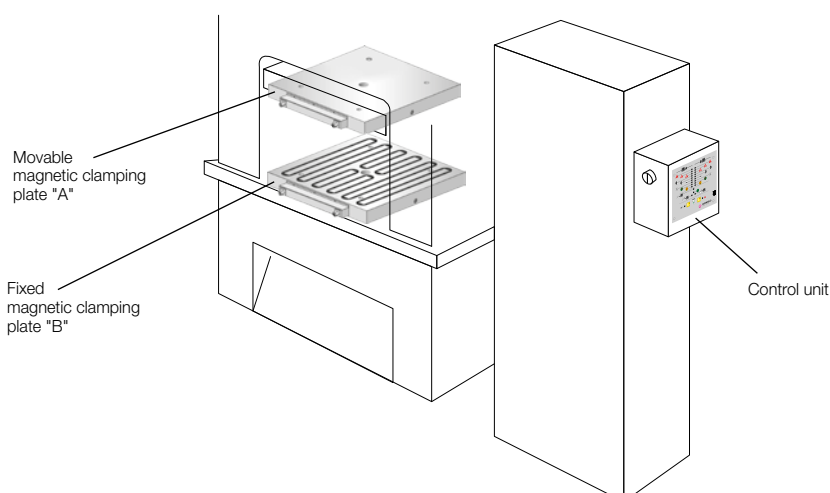

Advantages

- **QUICK** – Dies are clamped in one second at the touch of a button
- **PROFITABLE** – Setup cost optimization from die change that takes only a few minutes
- **FLEXIBLE** – Die standardization no longer required
- **ERGONOMIC** – Safe die handling with ease
- **RELIABLE** – Distortion-free and full-surface retention force even if power fails
- **SAFE** – Various sensors monitor the entire clamping cycle

Safety functions

- The inductive limit switch checks for form-fit contact of the die and guarantees clamping without force loss.
- Sensors inside the coils register the slightest die movements due to changes in the magnetic flow between the magnetic clamping plate and die.
- A temperature sensor in the magnetic clamping plate prevents overheating and thus damage to the system.

Function of the magnetic clamping plates

The electro-permanent magnetic clamping system is also firmly kept in place if the power fails. Power is only required for approx. 1 to 2 seconds to magnetize the system. After that, the clamping system works independently of any power supply. The magnetic clamping force is exclusively generated by the permanent magnets. Only when the mould is unclamped is electrical energy required again (1–2 seconds) to demagnetize the clamping plate. An existing AlNiCo magnet in the core is reversed in polarity by a current pulse. This magnet affects the magnetic field and relocates it completely to the interior of the magnetic clamping plate (demagnetized) or approx. 20 mm outside the plate (magnetized).

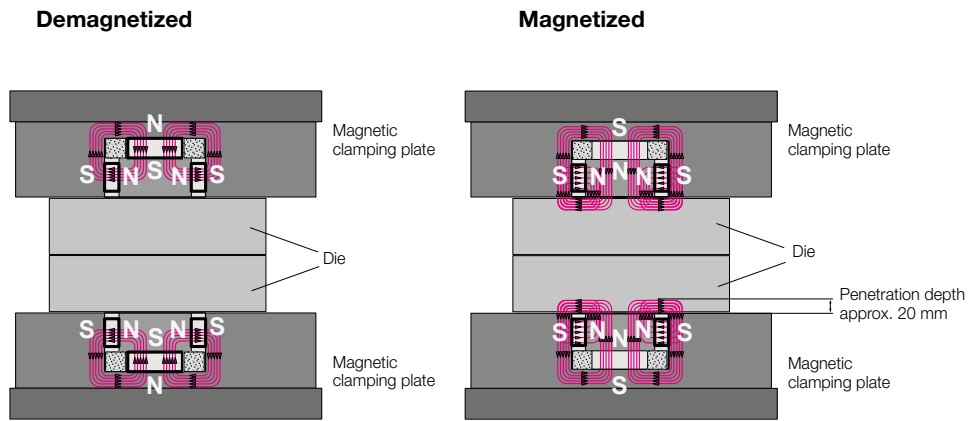

Magnetic clamping plate design

1. The fixing grid is designed to align with the existing bore holes to the greatest extent possible.
2. The mechanical limit switch checks for perfect contact of the die and then releases the magnetization.
3. Optional slots for roller or ball bars (also part of the ROEMHELD Group product range) can be inserted in the lower magnetic clamping plate to simplify die change.



Other safety devices in the plate:

- Sensors inside the coils respond to induction and report the slightest die movements.
- A temperature sensor in the magnetic clamping plate prevents overheating and thus damage to the system.

Power concentration of long pole technology

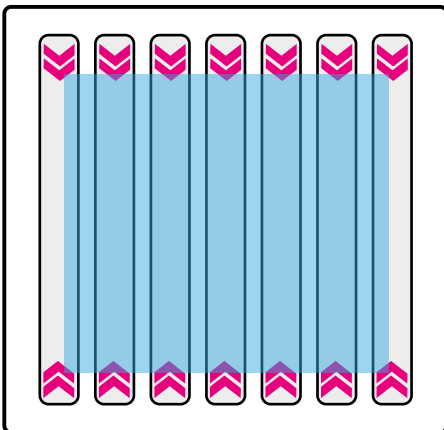

The magnetic field lines of the partially covered poles act in addition to the completely covered poles on the die and enable safe clamping of the smallest dies.

Electric control



- Highest safety standards as per EN201 and EN289
- Control via remote control or machine panel
- Simple error diagnosis via readout
- Easy and safe operation
- IP 54 splash-proof
- Error code indication on the LCD display
- Lacquering in preferred colour
- Integration via EUROMAP interface
- Easy to maintain with exchangeable master module
- Key switch protects from unauthorized operation

R-MAG-F Magnetic Clamping Systems for Mould Carriers and Special Applications

Operating temperature up to 100 °C



Advantages

- **QUICK** – Dies are clamped in one second at the touch of a button
- **PROFITABLE** – Setup cost optimization from die change that takes only a few minutes
- **FLEXIBLE** – Die standardization no longer required
- **ERGONOMIC** – Safe die handling with ease
- **RELIABLE** – Distortion-free and full-surface retention force even if power fails – with exchangeable poles in long pole technology
- **SAFE** – Various sensors monitor the entire clamping cycle with clamping force display in long pole technology

OUR HIGHLIGHTS

Long pole technology with:

- Extremely high clamping forces
- Clamping force display
- Interchangeable magnetic poles (without grinding)
- All-metal surface

Application

R-MAG-F magnetic clamping systems are used primarily for the automatic clamping of different dies in mould carrier presses and in vertical special applications.

Description

With magnetic clamping systems, the moulds are magnetically clamped or unclamped at the push of a button within a few seconds.

Since permanent magnets generate the force of the magnetic clamping plates, electric clamping is only required to magnetize the plates.

The magnetic clamping plates are de-energized in clamped condition and thus absolutely safe in case of power failure.

Additionally, the complete clamping cycle is monitored by different sensors, thus guaranteeing reliable die clamping.

Scope of system and delivery

R-MAG-F magnetic clamping systems are delivered as complete clamping systems with all required system components. The essential components of a system are:

- two magnetic clamping plates
- electric control in a splash-proof control box
- modern 8" colour touch panel
- required electrical connection cables

Customised versions

All R-MAG magnetic clamping systems are customized and manufactured to meet specific requirements.

For example, the size and pole technology of the magnetic clamping plates are selected according to the application and the machine.

Please contact us.

High safety standard thanks to:

- Inductive position monitoring of the die contact (switching distance 0.2 mm, adjustable)
- Redundant system with additional "flux sensor"
- Even the smallest die movements are monitored and reported
- Monitoring of correct magnetisation/power contacts
- Permanent temperature monitoring in the plate (overload protection)
- Standard interface according to EN 201/289 and Euromap

Technical Data

| | | |
|--------------------------------------|--------------------------|-----------------------------|
| Surface of the magnetic plate | | Metallic, smooth and sturdy |
| Size of the magnetic clamping plates | | Customised |
| Pole technology | | Long pole and square pole |
| Plate thickness | | |
| Long pole | <input type="checkbox"/> | [mm] 55 |
| Square pole | <input type="checkbox"/> | [mm] 38 or 55 |
| Max. temperature | | [°C] 100 |
| Magnetic retention force (per pole) | | |
| Long pole | 232 × 68 mm | [kN] 21 (2100 kg) |
| Square pole | 55 × 55 mm | [kN] 2 (200 kg) |
| Magnetic penetration depth | | [mm] 20 |



Function of the magnetic clamping plates

The electro-permanent magnetic clamping system is also firmly kept in place if the power fails. Power is only required for approx. 1 to 2 seconds to magnetize the system. After that, the clamping system works independently of any power supply. The magnetic clamping force is exclusively generated by the permanent magnets. Only when the mould is unclamped is electrical energy required again (1–2 seconds) to demagnetize the clamping plate. An existing AlNiCo magnet in the core is re-polarized by a current pulse. This magnet affects the magnetic field and relocates it completely to the interior of the magnetic clamping plate (demagnetized) or approx. 20 mm outside the plate (magnetized).

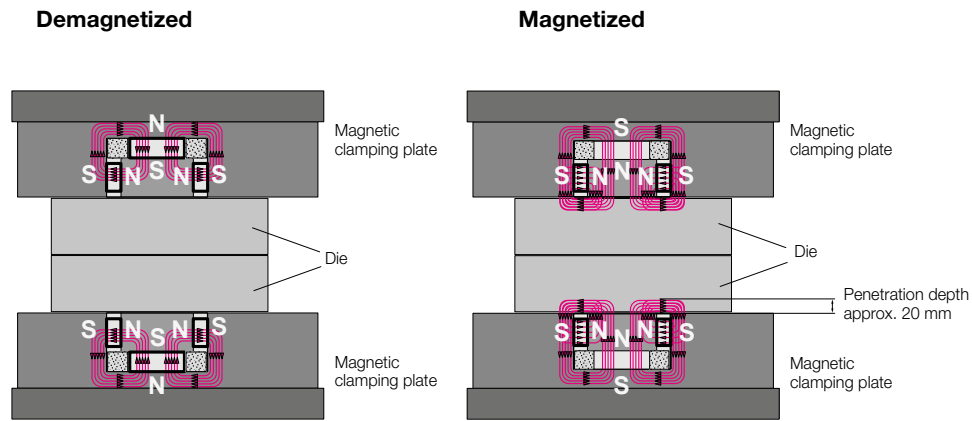

Available as an option:

- Control of external roller or ball bars
- Log files and all parameters stored on SD card
- Remote access via VPN, Ethernet, CAN-BUS, or RS485 protocol
- Higher operating temperature up to 230 °C
- When using R-MAG long poles:
 - With clamping force display (flux sensors in the plate)
 - Replaceable magnetic poles (without grinding)



R-MAG long pole technology



R-MAG square pole technology



Replacement of long poles

The long poles are pre-assembled and pluggable, allowing for easy replacement of the magnetic poles on site. Römheld offers you the option of replacing a (single) defective magnetic pole on site. This reduces system downtime.

User-friendly R-MAG control and touch panel

The 8-inch touchscreen is easy to read, sturdy and ideally suited for use on machines and systems. The housing has a LAN connection and/or an SD card slot. The display shows the status of the device and the available functions. The current clamping situation is always indicated and changes colour depending on the system status: red for important alarms and messages, orange/yellow for secondary problems, green for validation, and grey for basic functions.

Multiple access levels allow for different permissions for the operator. To ensure safety and traceability of use, a unique operator ID and password are created.

The remote access function uses a VNC protocol. This enables remote diagnosis by our ROEMHELD engineers. Even if the touchscreen is defective, all functions are available

on the service screen. This allows for remote troubleshooting or a system reset before on-site repair is necessary. The operator at the machine must confirm these processes. The buttons remain functional even if the touchscreen display is defective.



R-MAG-D Magnetic Clamping Systems for Die Casting Machines

Operating temperature up to 200 °C

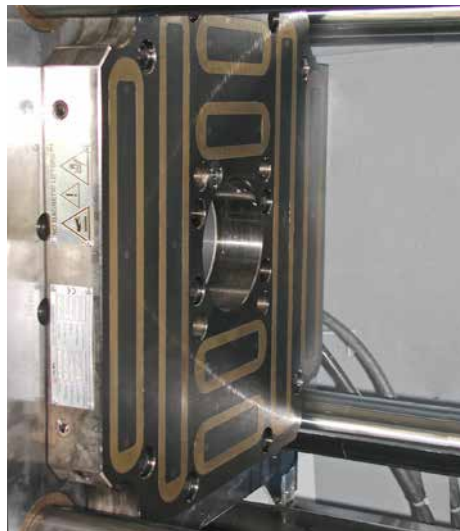

Ejector side

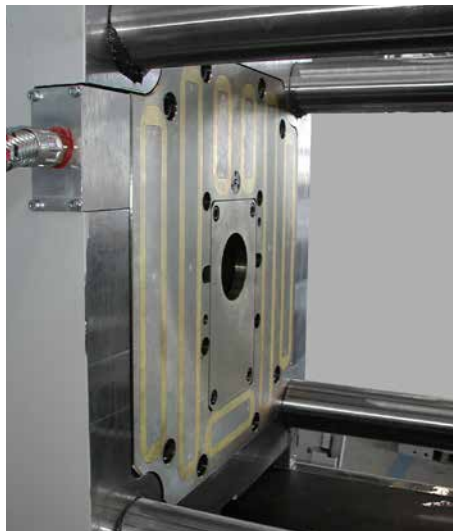

Nozzle side

Application

R-MAG-D magnetic clamping systems are primarily used for automatic clamping of different dies on rubber presses.

Description

With magnetic clamping systems, the moulds are magnetically clamped or unclamped at the push of a button within a few seconds.

Since permanent magnets generate the force of the magnetic clamping plates, electric clamping is only required to magnetize the plates.

The magnetic clamping plates are de-energized in clamped condition and thus absolutely safe in case of power failure.

Additionally, the complete clamping cycle is monitored by different sensors, thus guaranteeing reliable die clamping.

Scope of system and delivery

R-MAG-D magnetic clamping systems are delivered as complete clamping systems with all required system components. The essential components of a system are:

- two magnetic clamping plates
- electric control in a splash-proof control box
- A manual remote control
- required electrical connection cables

Advantages

- **QUICK** – Dies are clamped in one second at the touch of a button
- **PROFITABLE** – Setup cost optimization from die change that takes only a few minutes
- **FLEXIBLE** – Die standardization no longer required
- **ERGONOMIC** – Safe die handling with ease
- **RELIABLE** – Distortion-free and full-surface retention force even if power fails
- **SAFE** – Various sensors monitor the entire clamping cycle

Customised versions

All R-MAG magnetic clamping systems are customized and manufactured to meet specific requirements.

For example, the size and pole arrangement of the magnetic clamping plates are selected according to the application and the machine. Please contact us.

Safety functions

- The inductive limit switch checks for form-fit contact of the die and guarantees clamping without force loss.
- Sensors inside the coils register the slightest die movements due to changes in the magnetic flow between the magnetic clamping plate and die.
- A temperature sensor in the magnetic clamping plate prevents overheating and thus damage to the system.

Technical Data

| | | |
|--------------------------------------|-----------------------|------------|
| Size of the magnetic clamping plates | | Customised |
| Pole technology | | Long pole |
| Max. temperature | [°C] | 200 |
| Effective magnetic force | [kg/cm ²] | 5–12 |
| Magnetic penetration depth | [mm] | 20 |
| Plate thickness | [mm] | min. 55 |

* force directly on the magnet

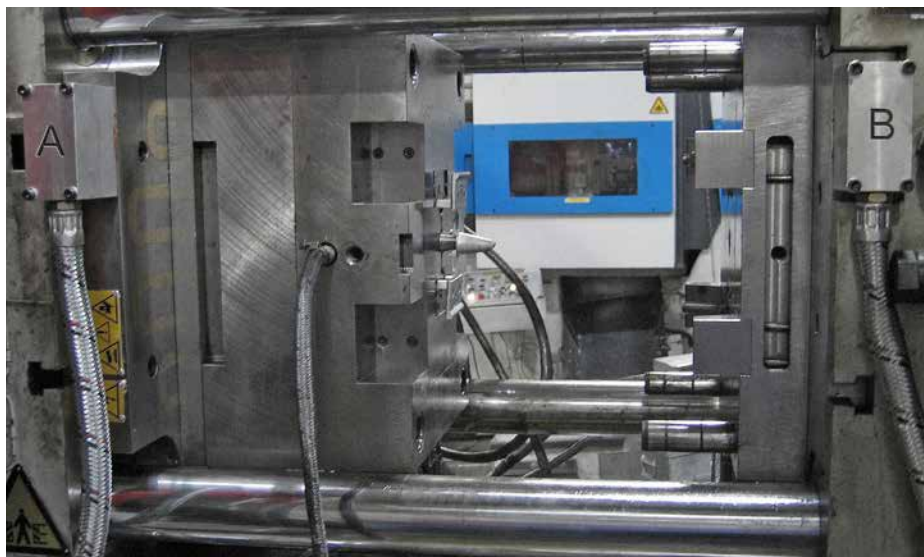

Magnetic clamping system integrated in a die casting machine

Function of the magnetic clamping plates

The electro-permanent magnetic clamping system is also firmly kept in place if the power fails. Power is only required for approx. 1 to 2 seconds to magnetize the system. After that, the clamping system works independently of any power supply. The magnetic clamping force is exclusively generated by the permanent magnets. Only when the mould is unclamped is electrical energy required again (1–2 seconds) to demagnetize the clamping plate. An existing AlNiCo magnet in the core is re-polarized by a current pulse. This magnet affects the magnetic field and relocates it completely to the interior of the magnetic clamping plate (demagnetized) or approx. 20 mm outside the plate (magnetized).

Demagnetized

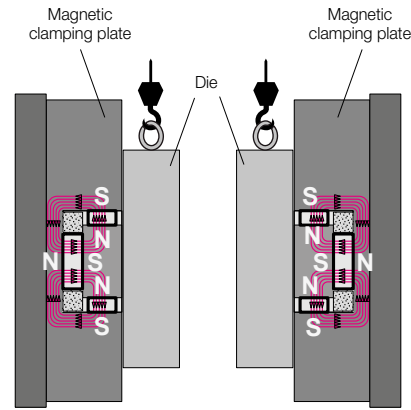

Magnetized

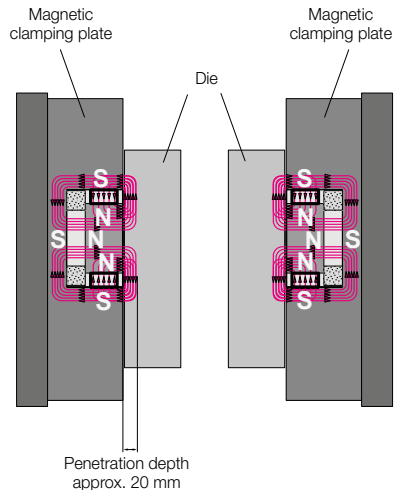

Magnetic clamping plate design

1. The fixing grid is designed to align with the existing bore holes to the greatest extent possible.
2. The mechanical limit switch checks for perfect contact of the die and then releases the magnetization.
3. Optional slots for roller or ball bars (also part of the ROEMHELD Group product range) can be inserted in the lower magnetic clamping plate to simplify die change.



Other safety devices in the plate:

- Sensors inside the coils respond to induction and report the slightest die movements.
- A temperature sensor in the magnetic clamping plate prevents overheating and thus damage to the system.

Power concentration of long pole technology

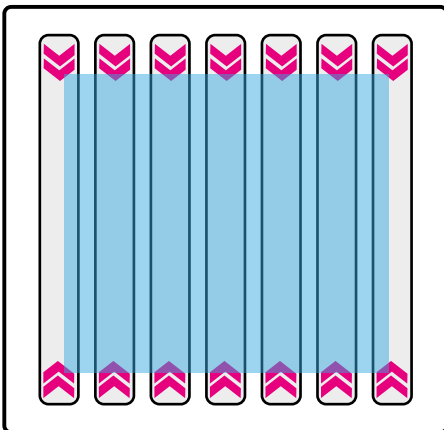

The magnetic field lines of the partially covered poles act in addition to the completely covered poles on the die and enable safe clamping of the smallest dies.

Electric control



- Highest safety standards as per EN201 and EN289
- Control via remote control or machine panel
- Simple error diagnosis via readout
- Easy and safe operation
- IP 54 splash-proof
- Error code indication on the LCD display
- Lacquering in preferred colour
- Integration via EUROMAP interface
- Easy to maintain with exchangeable master module
- Key switch protects from unauthorized operation

Insulation plates

The insulation plates are mounted between the machine table and the magnetic clamping plates. They enable uniform heat distribution and prevent heat from passing from the die to the machine.

The insulation plates are available with a thickness of 6 and 10 mm.

Since the magnetic clamping plates are equipped with firmly mounted insulation plates, this investment is not required for all new dies.

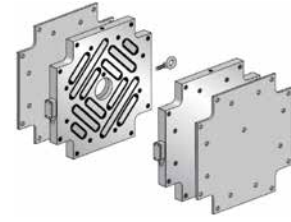

Eccentric ring

Too many tool changes can wear the centring on the magnetic clamping plate. An exchangeable centring ring guarantees the precise centring of the dies without exchanging the complete clamping system.



Wedge clamping elements in hydraulic or electric versions

Data sheet WZ 2.2450



Data sheet WZ 2.2451



Data sheet WZ 5.2670



Roller or ball bars

Roller and ball bars in the lower magnetic clamping plate allow easy and trouble-free die change and prevent damages to the surface.

Data sheets WZ 8.18340 – 8.18347



See roller and ball bar configurator:
<https://www.roemheld-gruppe.de/productconfigurator/?lang=en>

Driven die changing systems

Data sheet WZ 8.18362



Combination of push chain direct system with standard carrying console

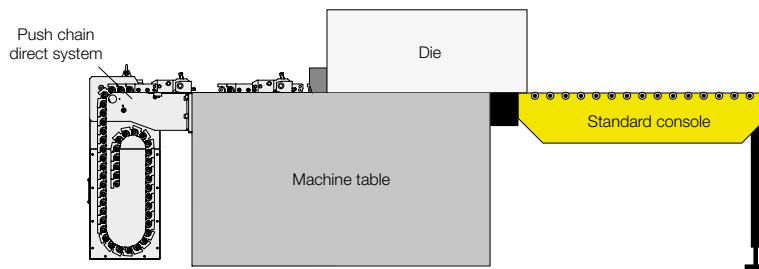

Die changing carts and carrying consoles

Data sheet WZ 8.8900



Data sheet WZ 8.8904



Data sheets WZ 8.18350 – 8.18354

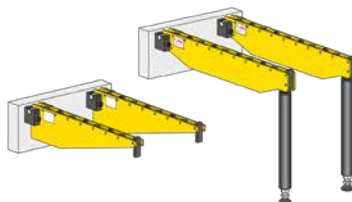

Magnetic clamping systems also available for:

- Sheet metal forming
- Plastics industry
- Rubber moulding presses
- Mould carriers
- Die casting machines



Discover the QDC app now!

<https://wz-app.roemheld.de/en/home>



| | | | |
|--|--|--|---|
| <p>Argentina Nelso Ferreyra S.R.L. Ing. Huergo 1387 Parque Industrial-C.C. No. 144 C.P. 2400 San Francisco-Córdoba Phone +54 3564 420755 ventas@dri-lex.com www.dri-lex.com</p> | <p>Australia Romheld Automation Pty Ltd. Unit 7, 62-66 Turner Road Smeaton Grange, NSW 2567 Phone +61 29721 1799 sales@romheld.com.au www.romheld.com.au</p> | <p>Belgium ITB Benelux BV Minervum 7215 4817 ZJ Breda Phone +31 162 43 1691 info@itb-bv.nl www.itb-bv.nl</p> | <p>Brazil Sanposs TSCI Ltda. Rua Cândia nº 65 – Jardim do Mar São Bernardo do Campo – São Paulo, 09726-220 Phone +55 11 4126 6711 sanposs@sanposs.com.br www.sanposs.com.br</p> |
| <p>China Roemheld Production Systems (Nanjing) Co., Ltd. 27-1 Guangyue Road, Qixia District 210033 Nanjing Phone +86 2585766862 info@roemheld-china.com www.roemheld.com</p> | <p>Denmark Duroc Machine Tool Danmark Ribevej 14 8940 Randers SV Phone +45 86 412011 info.machinetool.dk@duroc.com www.duroc.com</p> | <p>France Roemheld S.A.S. 2 rue Parc des Vergers 91250 TIGERY Phone +33 1 64979740 info@roemheld.fr www.roemheld.fr</p> | <p>Finland Tanreco Oy Konepajankatu 11 11710 Riihimäki Phone +358 19 77 485 myynti@tanreco.fi www.tanreco.fi</p> |
| <p>Great Britain ROEMHELD UK Ltd. Unit 9 B Village - Endeavour Park Baker Road - Nelson Park West Cramlington NE23 1XA Phone +44 1670 281400 sales@roemheld.co.uk www.roemheld.co.uk</p> | <p>India Oriental Engineering Works Pvt. Ltd. Oriental Crossing, Industrial Area Yamuna Nagar 135 001 (Haryana) Phone +91 1732 25 1750 info@oewin.com www.oewin.com</p> | <p>Italy CAMAR S.p.A. Via Genova 58/A 10098 Cascine Vica-Rivoli (TO) Phone +39 011 959.16.26 r.a info@camarspa.it www.camarspa.it</p> | <p>Japan Roemheld · Halder Co., Ltd. 2-14-8 Yushima, Bunkyo-ku Tokyo 113-0034 Phone +81 03 6284 2501 info@roemheld-halder.co.jp www.roemheld-halder.co.jp</p> |
| <p>Netherlands ITB Benelux BV Minervum 7215 4817 ZJ Breda Phone +31 162 43 1691 info@itb-bv.nl www.itb-bv.nl</p> | <p>Norway Duroc Machine Tool AS Anolitveien 7 1401 Ski Phone +47 64 91 4880 info.machinetool.no@duroc.com www.duroc.com</p> | <p>Austria B-S-D Spanntechnik GmbH Sportplatzstraße 31 3385 Markersdorf Phone +43 2749 72870 office@bsdustria.com www.die-spanntechniker.at</p> | <p>Poland INMET-BTH® ul. Jasna 1–5 43 –190 Mikołów Phone +48 32 738 4949 Mobil +48 604 268 726 biuro@roemheld.pl www.roemheld.pl</p> |
| <p>Portugal DRIFTEC, Lda Rua Adelino Amaro da Costa, nº 330 4470-225 Maia Phone +351 962 502614 driftec@driftec.pt www.driftec.pt</p> | <p>Romania SC PARCON FREIWALD SRL Str. Depozitelor Nr. 22 540240 Târgu Mures Phone +40 365 410572 comert@parconfreiwald.ro www.parconfreiwald.ro</p> | <p>Russia DIFLEX LLC 3 Okskaya Naberezhnaya, Dzerzhinsk 606030 Nizhniy Novgorod Region Phone +7 831 2287455 info@roemheld.ru www.roemheld.ru</p> | <p>Sweden Duroc Machine Tool AB Snedgatan 1 342 50 Vislanda Phone +46 8630 2300 info.machinetool.se@duroc.com www.duroc.com</p> |
| <p>Switzerland FN Niederhauser AG Spanntechnik und Systeme Allmend 39, 6204 Sempach Phone +41 41 3405075 info@niederhauser.ch www.niederhauser.ch</p> | <p>Singapore Techpro Machine Tools Pte. Ltd. Block 2021, Street 23 Bukit Batok Industrial Park A, Unit 02-190 Singapore 659526 Phone +65 6567 6677 enquiry@techpro.com.sg www.techpro.com.sg</p> | <p>Slovenia Halder norm + technik d.o.o. Miklavška cesta 50 2311 Hoče Phone +386 2 61 82 646 info@halder.si www.halder.si</p> | <p>Spain OBON Técnica de sujeción, S.L. Calle B, número 10 Polígono Industrial Can Xinxà 08348 Cabrils (Barcelona) Phone +34 93 576 87 10 info@obonsl.es</p> |
| <p>South Africa Stefan Hulme Clamping Technology Bokmakierie Street, Theresapark, Villa Casia Pretoria Phone +27 82 478 9111 stefan@ctza.co.za www.clampingtechnology.co.za</p> | <p>South Korea Halder Roemheld Korea Ltd. B-1405 Woolim Lions Valley 2 Cha, 146-8 Sangdaewon-dong, Jungwon-gu Seongnam-si, Gyunggi-do, South Korea Phone +82 31 4554762 info@halder-roemheld.co.kr www.halder-roemheld.co.kr</p> | <p>Taiwan Jimmore International Corp. 120-2 Sec. 2 Fusing Road, South District Taichung City 40252 · Taiwan Phone +886 4 2260 5352 trade@jimmore.com.tw www.jimmore.com.tw</p> | <p>Thailand Krasstec Co., Ltd. 1205 Rama 9 Soi 55 Rama 9 Road Suan Luang - Bangkok 10250 Phone +66273 21144 krasscom@krasstec.com www.krasstec.com</p> |
| <p>Czech Republic Presston spol s.r.o. Božetěchova 50 61200 Brno Phone +420 541 248 853 presston@presston.cz www.presston.cz</p> | <p>Turkey Hidkom Mühendislik-Müessillik Ltd. Organize Sanayi Bölgesi 75, Yıl Cd. Demirciler Sit. BBlok No.2 16220 Nilüfer / Bursa Phone +90 224 2438292 hidkom@hidkom.com www.hidkom.com</p> | <p>Hungary GIMEX Hidraulika Kft Selyem utca 1 9025 Győr Phone +36 96 525588 info@gimex.hu www.gimex.hu</p> | <p>USA / Canada / Mexiko ROEMHELD North America 927 Horan Drive Fenton, Missouri 63026 Phone +1 636 386 8022 info@roemheld-usa.com www.roemheld-usa.com</p> |



ROEMHELD

HILMA ■ STARK



Centre/North
Benedikt Niklas
 Area Manager QDC/QMC
 +49 172 629 70 70
 b.niklas@roemheld.de

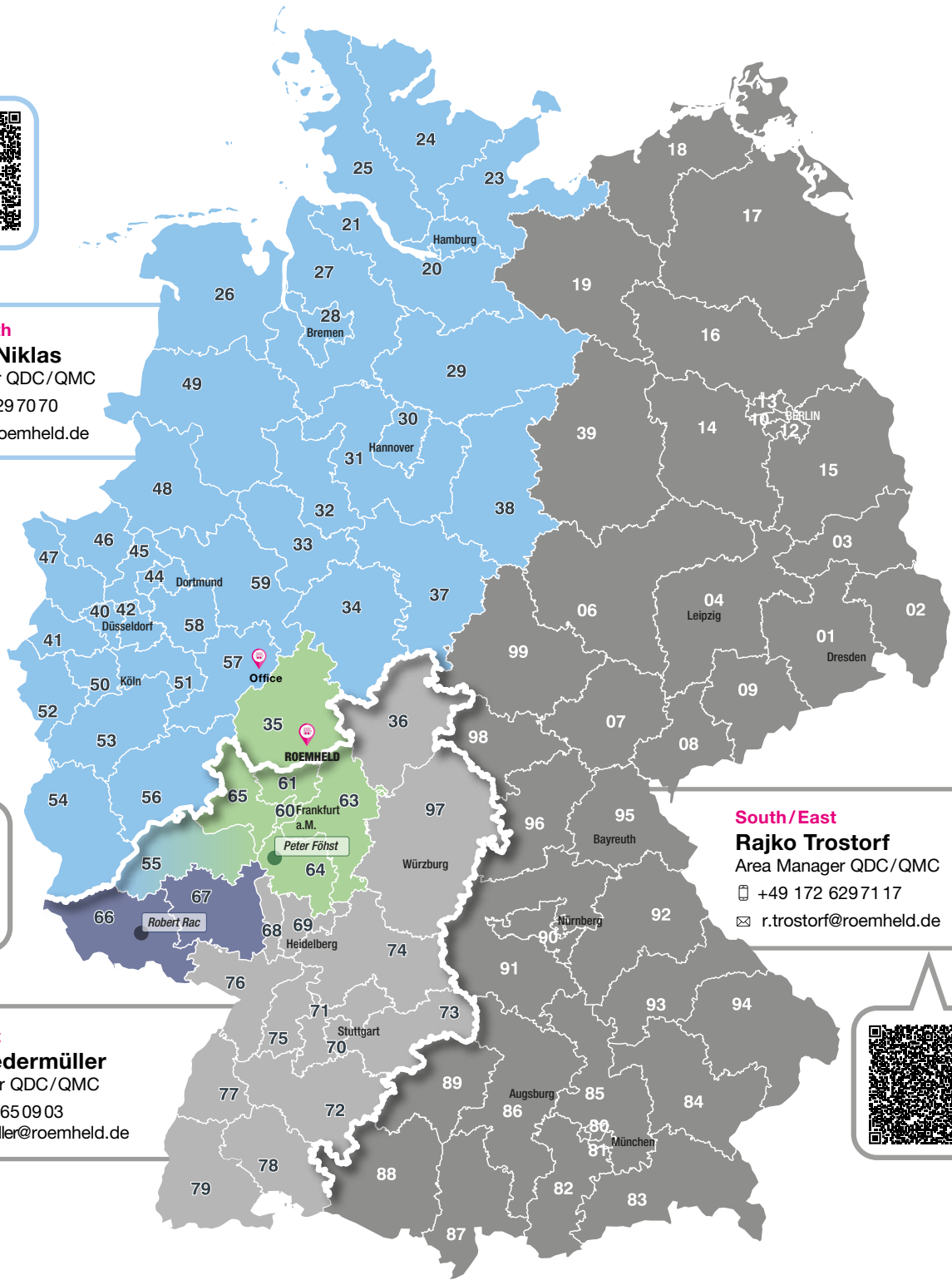

South/West
Jonas Niedermüller
 Area Manager QDC/QMC
 +49 172 265 09 03
 j.niedermueller@roemheld.de

South/East
Rajko Trostorf
 Area Manager QDC/QMC
 +49 172 629 71 17
 r.trostorf@roemheld.de



Römheld GmbH
 Friedrichshütte
 Römheldstraße 1–5
 35321 Laubach, Germany
 Phone: +49 6405 89-0
 info@roemheld.de
 www.roemheld.com



Römheld GmbH
 Friedrichshütte
Die Clamping and Changing Technology Office:
 Auf der Landeskronen 2
 57234 Wilnsdorf-Wilden, Germany
 Phone: +49 2739 4037-0
 info@roemheld.de
 wz.roemheld.com

Contact Person for Die Clamping and Changing Systems

Area: Centre / North

35300–35305
35321–35327
35390–35649
35745–35767
35781–35999
55000–55218
55239–55283
55294–55411
55435–55437
60–65

Peter Föhst
Römheld GmbH Friedrichshütte
Römheldstr. 1-5
35321 Laubach

☎ +49 172 672 67 80
✉ p.foehst@roemheld.de

20–34
35288
35315
35329
35683–35719
35768
36–38
40–59

Benedikt Niklas
Römheld GmbH Friedrichshütte
Office:
Auf der Landeskronen 2
57234 Wilnsdorf-Wilden

☎ +49 172 629 70 70
✉ b.niklas@roemheld.de

Area: East

01–09
1
8
39
90000–96999
98–99

Rajko Trostorf
Römheld GmbH Friedrichshütte
Office:
Auf der Landeskronen 2
57234 Wilnsdorf-Wilden

☎ +49 172 629 71 17
✉ r.trostorf@roemheld.de

Area: South/West

36
70–79
68
69
97

Jonas Niedermüller
Römheld GmbH Friedrichshütte
Office:
Auf der Landeskronen 2
57234 Wilnsdorf-Wilden

☎ +49 172 265 09 03
✉ j.niedermueller@roemheld.de

66
67

Dipl.-Ing Robert Rac
Römheld GmbH Friedrichshütte
Römheldstr. 1-5
35321 Laubach

☎ +49 172 630 31 61
✉ r.rac@roemheld.de

Everything for a quick and safe die change on presses, machines and plants

from storage, transport and insertion to positioning and clamping of dies

Complete solutions from a single source!

Your advantages

- Quick die change - easy and safe
- Reduction of set-up times
- Possible automation of the die change
- Higher productivity

RACK SYSTEMS FOR DIE STORAGE

Heavy duty shelving with integrated ball and roller bars

STORAGE



DIE CHANGING CARTS

for the safe handling of heavy dies

TRANSPORT



CARRYING CONSOLES / ROLLER AND BALL BARS

for the movement of dies

INSERTION



DIE CLAMPING SYSTEMS

hydraulic, magnetic,
elektro-mechanical or mechanical

POSITIONING AND CLAMPING



Römheld GmbH

Friedrichshütte
Römheldstraße 1–5
35321 Laubach, Germany

Tel.: +49 6405 89-0
info@roemheld.de
www.roemheld.com

Römheld GmbH

Friedrichshütte
**Die Clamping and Changing Technology
Office:**
Auf der Landeskronen 2
57234 Wilsdorf-Wilden, Germany

Tel.: +49 2739 4037-200
info@roemheld.de
wz.roemheld.com