

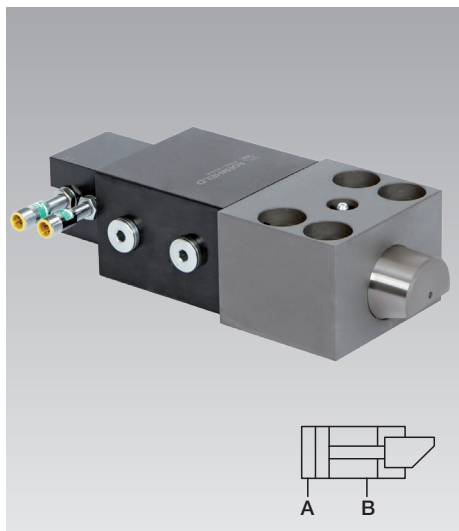

Wedge Clamps for Tapered Clamping Edge

double acting, max. clamping force 25 to 630 kN,
with adjustable position monitoring at the back



Advantages

- The clamping range can be flexibly adjusted
- Safe clamping of moulds/dies with tapered clamping edge
- High operational safety by adjustable position monitoring and automatic motion sequence
- Very sturdy design
- High safety standard
- Long service life
- Sizes up to 1250 kN are available on request

Important notes

In case of incorrect operation of the wedge clamps, the clamping bolt may fully retract into the guide housing and thus cause the upper mould/die falling off the ram.

The greasing intervals (high temperature grease) should be adapted to the existing operating conditions. Please note that greasing of the wedge bolt should only be made with the elements being retracted.

The clamping elements must be protected against dirt, scale, swarf, coolant, etc. by means of a suitable covering.

Moulds or dies clamped by means of wedge clamps are subject to side loads that may be strong enough to displace them. Thus, positioning is required to absorb the side loads. Therefore, location pins or suitable limit stops should be provided to keep the moulds and dies in their correct position.

When using wedge clamps on the press ram, it is recommended that multiple-circuit hydraulic supply of the clamping elements and pilot-controlled check valves are used for securing hydraulic clamping.

Circuit diagram

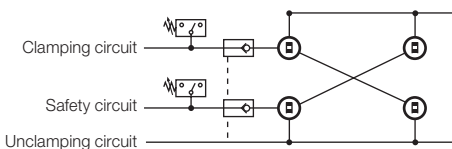

For safety reasons and in the sense of the machine tool guide lines ML2006/42/ EC the hydraulic pressure must be maintained.

When upper moulds/dies are clamped by wedge clamps, they must be secured mechanically when maintenance work is carried out.

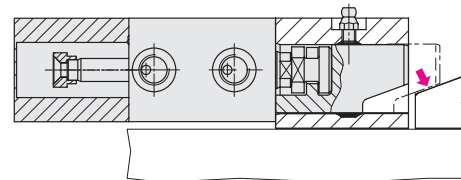

Versions

- with position monitoring at the back
max. temperature: 80 °C (type A and B)
max. temperature: 120 °C (type C)

Position monitoring

Inductive proximity switches installed in the flange-mounted housing. The proximity switches are activated by a control cam connected to the piston.

The position monitoring will be screwed on at the cylinder bottom and can also be mounted in a position rotated by 180°.

Different versions are available according to the application conditions.

The integrated position monitoring is coupled to the clamping bolt in a very space-saving way at the back and signals:

1. Clamping bolt in unclamping position
2. Clamping bolt in clamping position
3. Error message when overrunning the clamping position

Clamping force

This is the force the clamping element applies to the mould or die. The mould or die is clamped on the fixture plate by means of this force.

The external forces acting on mould or die (e.g. ejecting force or die cushion force) shall not exceed the totality of the elements' clamping force.

Maximum admissible operating force

This is the force that can be absorbed by the clamping element and the fastener (screws).

It must be ensured that in cases of emergency, e.g. workpiece jammed in mould or die, the sum total of the elements' operating forces is not exceeded.

Application

Double-acting wedge clamp for clamping moulds or dies on a press bed or ram or in injection moulding machines, machines and installations.

Description

The wedge clamp consists of a hydraulic block cylinder and a piston guided in a housing. The clamping bolt is provided with 20° bevel to clamp on the tapered clamping surface of the mould/die.

Based on the internal design of the wedge clamp and the 20° bevel of the clamping bolt, the system is providing internal friction.

Retrofitting to wedge clamping

Wedge clamping of existing moulds/dies is possible by retrofitting V-shaped inserts as shown below. Max. hardness 50 HRc

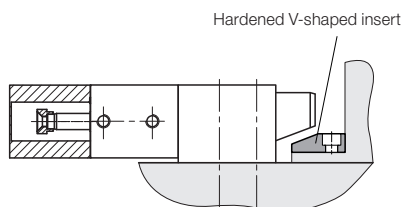

Wedge clamps with position monitoring at the back, adjustable

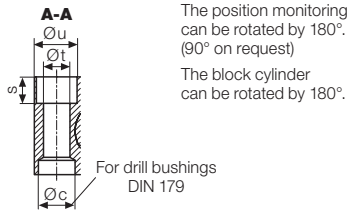
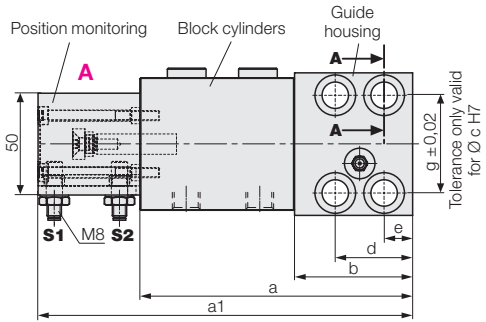
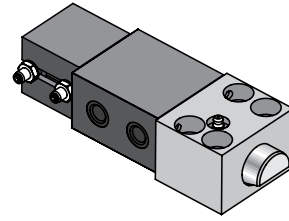
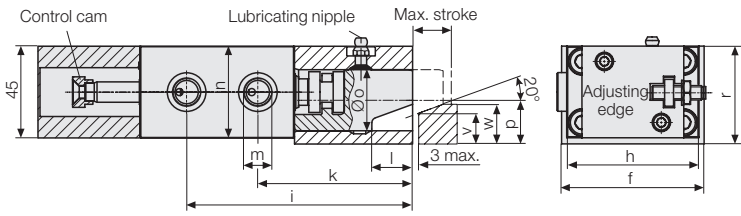

The position monitoring can be rotated by 180°. (90° on request)
The block cylinder can be rotated by 180°.

Installation of drill bushings to absorb side loads
The occurring side loads must be absorbed by drill bushings to be inserted into the fixture plate.

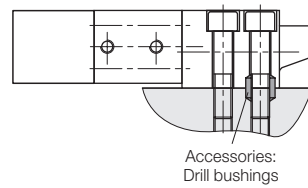
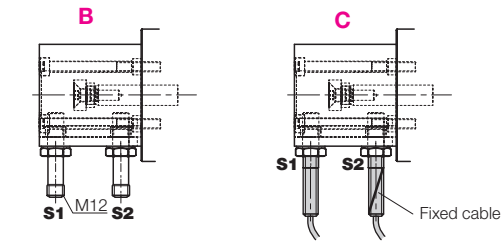

The position monitoring is available in 3 variants:

- Type A** – compact version for connector M8
- Type B** – sturdy long version for connector M12
- Type C** – High-temperature version up to 120°C with attached cable (L = 5 m)

Please indicate the desired type in your order, behind the part no., e.g.: **4604670-A**

- A** = Type A
- B** = Type B
- C** = Type C

Technical data

Temperature resistance see page 3

Clamping force max.	[kN]	25*	50	100	160	250	400	630
Max. admissible operating force								
Screw DIN 912 8.8	[kN]	35	65	130	210	320	520	820
Max. operating pressure	[bar]	350	275	350	350	350	350	350
Cylinder Ø	[mm]	25	40	50	63	80	100	125
Max. stroke	[mm]	20	25	25	30	32	40	40
Clamping stroke (from/to)	[mm]	15 – 18	18 – 22	19 – 22	23 – 27	24 – 29	30 – 36	30 – 36
a	[mm]	134	168	200	235	270	310	375
a1	[mm]	184	218	250	285	330	370	435
b	[mm]	58	78	100	125	150	180	225
Ø c H7 x depth	[mm]	18/7	26/9	30/11	35/11	48/13	55/16	62/16
d	[mm]	38	46	58	75	78	95	108
e	[mm]	14	16	20	25	26	32	38
f	[mm]	70	95	120	150	200	240	280
g	[mm]	48	65	85	106	140	180	210
h	[mm]	65	85	100	125	160	200	230
i	[mm]	111	146	177	210	246	285	344
k	[mm]	76	102	127	151	184	215	272
l	[mm]	20	25	26	32	40	45	50
m		(4x) G 1/4	(4x) G 1/4	(4x) G 1/4	(4x) G 1/2	(2x) G 1/2	(2x) G 1/2	(2x) G 1/2
n	[mm]	45	63	75	95	120	150	180
Ø o	[mm]	30	40	55	70	80	100	125
p	[mm]	21.5	28	37	49	55	75	85
r	[mm]	48	65	80	105	125	160	190
s	[mm]	13	18	20	26	32	38	44
Ø t	[mm]	13	17	21	26	33	39	45
Ø u	[mm]	20	26	32	40	48	57	66
v	[mm]	15	18	25	30	30	50	60
w	[mm]	19.5	23.5	30.5	37	38	60	70
Screw DIN 912-8.8 (4 off)		M 12	M 16	M 20	M 24	M 30	M 36	M 42
Tightening torque	[Nm]	86	210	410	710	1450	2520	4050
Weight	[kg]	3.0	6.5	11.4	21.7	41	74.7	126
Part no.		4604670	4604671	4604672	4604673	4604674	4604675	4604676

Accessories

Drill bushings DIN 179	[mm]	12 x 12	17 x 16	21 x 20	26 x 20	32 x 25	38 x 30	44 x 30
Part no.		3300285	3300287	3300288	3300289	3300420	3300430	3300440

* lubricating nipples of the version with a clamping force of 25 kN are offset by 9.5 mm and protrude by 5 mm

Position monitoring, adjustable

Description

Inductive proximity switches installed in the flange-mounted housing. The proximity switches are activated by a control cam connected to the piston.

The position monitoring will be screwed on at the cylinder bottom and can also be mounted in a position rotated by 180°.

Different types are available according to the application conditions. A control cam is provided at the extended piston rod causing the activation of the proximity switches. Adjustment of the switching position is effected by displacement of the proximity switches in the lateral groove. The proximity switches are switched on in a stroke range of approx. 6 mm by means of the control cam. The minimum distance to the positions to be monitored depends on the switch type and is indicated in the chart.

Message of proximity switches

S1: Clamping bolt in unclamping position

S2: Clamping bolt in clamping position

S2 is overrun: Clamping bolt in final position (message for no mould/die available or mould/die not clamped)

Design

Careful design is required, corresponding application conditions and safety measures have to be planned and guaranteed.

Electric circuit diagram

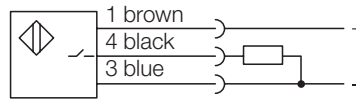

Technical data

for inductive proximity switches

Operating voltage	10 ... 30 V DC
Ripple	max. 15 %
Switching function	interlock
Output	PNP
Housing material	steel, corrosion resistant
Code class (DIN 40050)	IP 67

Type A

Compact version M8

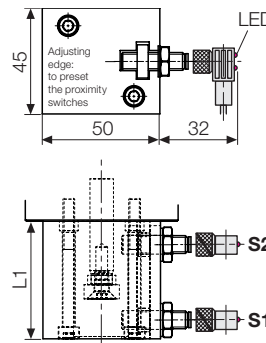

Type B

Long version M12

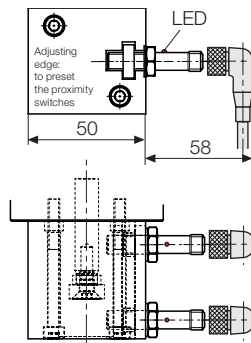

Type C

High ambient temperature

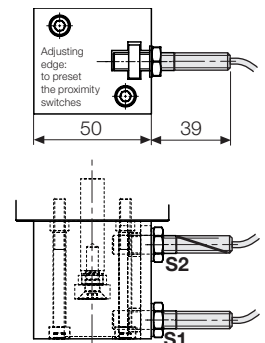

		-25° ... +80 °C	-25° ... +80 °C	-25° ... +120 °C
Environmental temperature TA		-25° ... +80 °C	-25° ... +80 °C	-25° ... +120 °C
Min. distance of the switching positions	[mm]	8	13	8
Type of connection		Connector	Connector	Teflon cable 3 x 0.14 mm ²
LED function display		in the connector	yes	no
Constant current max.	[mA]	200	200	200 – (from 70 °C) 100
Rated operating distance	[mm]	1.5	1.5	2
Protected against short circuits		yes	yes	no
Connecting cable	[m]	5	5	5
Proximity switches	Part no.	638290980	3829077	638290870
Connector with cable	Part no.	3829099	209750024	firmly connected
L1 complete (without connector) up to type 4604-673	[mm]	50	50	50
Position monitoring up to a total stroke of 30 mm	Part no.	762820010-A	762820010-B	762820010-C
L1 complete (without connector) from type 4604-674	[mm]	60	60	60
Position monitoring up to a total stroke of 50 mm	Part no.	762820011-A	762820011-B	762820011-C