



Accessories for Venting of the Spring Area of single-acting clamping elements and work supports

Introduction

Due to increased use of coolants and cutting fluids in metal cutting machining there is also an increased danger that some very aggressive fluids penetrate into the spring areas of single-acting clamping elements and work supports, causing malfunctions.

It is important to realize these problems already in the period of design. The following versions show possible solutions to the above problems.

Catalogue elements with venting of the spring area

Single-acting clamping elements

without venting port

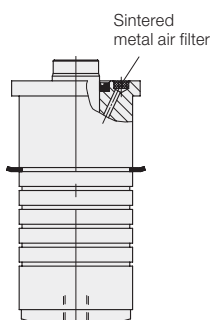

with venting port

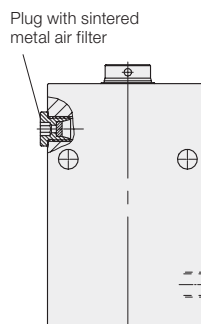

Work supports

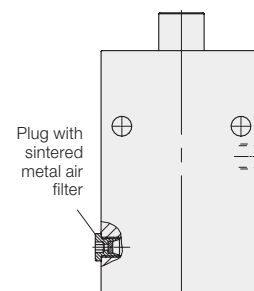

See data sheets:

B 1.310
B 1.480

B 1.309
B 1.5091
B 1.570
B 1.7441
B 1.849
B 1.880
B 1.881
B 1.891
B 1.892

B 1.900 **B 1.943**
B 1.910 **B 1.944**
B 1.911 **B 1.9470**
B 1.914 **B 1.9471**
B 1.921 **B 1.9472**
B 1.9401 **B 1.950**
B 1.9405 **B 1.9501**
B 1.942 **B 1.9503**

Why venting has to be made?

Excess pressure or depression in the spring area change the spring forces which leads to malfunctions.

Formation of condensation water promotes rust formation and can lead to a complete failure of the elements.

Leakages of hydraulic seals must drain off to the exterior without pressure, otherwise there will be malfunctions.

Dust and swarf are retained by sintered metal air filters.

Liquids are the real problem, because they are drawn off through the air filter. Thereby the breathing spring area is reduced, a higher excess pressure or depression is caused and the function is impaired.

What happens during venting?

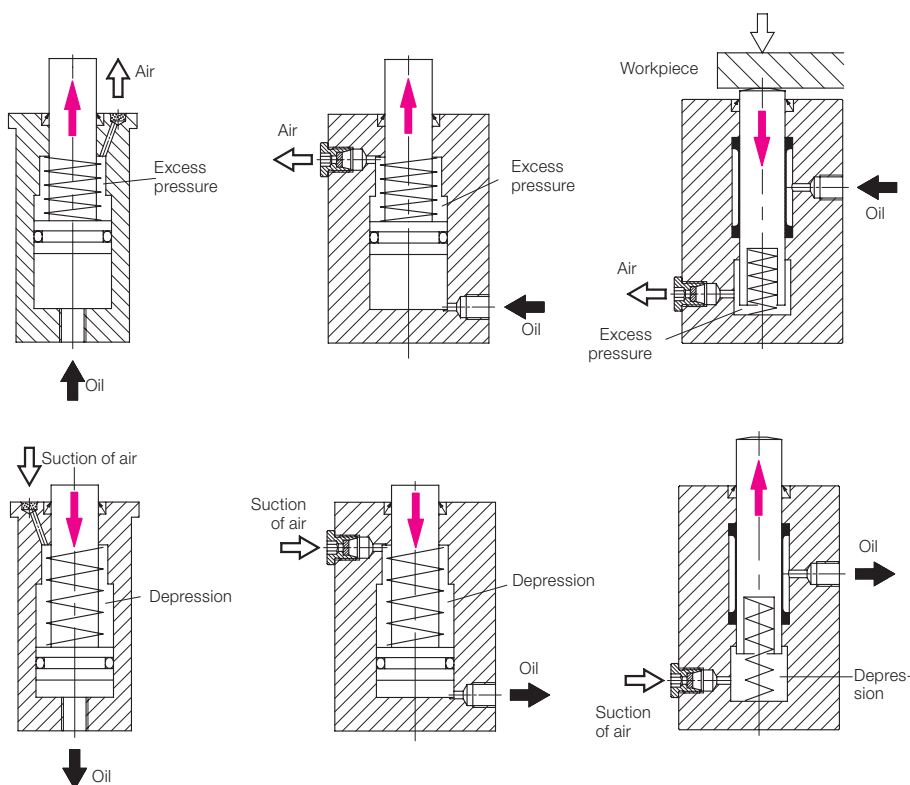

Precautions

If there is the danger that liquids enter the system, you have to prevent it.

Cover

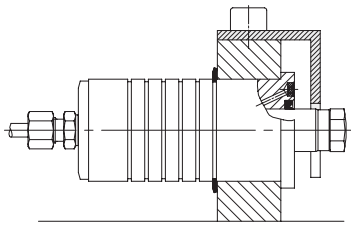

Clamping elements without venting port can be covered, but due to the nowadays usual quantities of coolants this does not seem to be successful. In such applications you should use other clamping elements, preferably double-acting elements.

Closed venting system

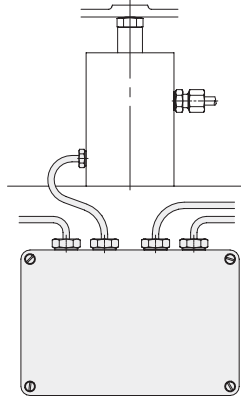

The spring area shall be increased by the connection of an additional area so that only a little excess pressure or depression will be generated so that neither the functioning of the elements will be influenced nor liquids will be drawn off. Electric wiring boxes provided with connecting threads for venting hoses proved to be worthwhile. The volume of this "additional area" should be **ten times the stroke volume** of all connected elements.

Venting hose

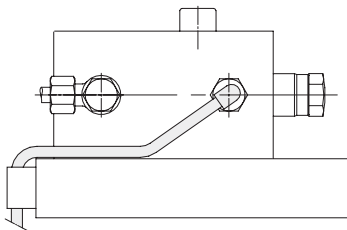

Connection of a venting hose is indicated if the opening is displaced to a point where no liquid can penetrate.

Important note

In the case of temperature variations, condensation water can precipitate in a closed ventilation system. Possibly also coolants can enter into the system through the connected clamping elements and work supports.

Recommendation

Open the empty housing regularly (depending on the operating conditions) and dry the interior.

Venting accessory

Plastic hose

for the following connecting elements

Part no.

black **3890131**

Insertion nipple fitting

Size

Part no.

M 5 **3890091**

1/8 **3890092**

1/4 **3890093**

L-insertion nipple fitting

swivelling

Size

Part no.

M 5 **3890094**

1/8 **3890095**

1/4 **3890096**

L-insertion nipple distributor

Part no.

3890097

Hose connection L-piece 90°

Part no.

3890098

Steel tubes and fittings

see data sheet F 9.300

Empty housing, material: aluminium, grey lacquered

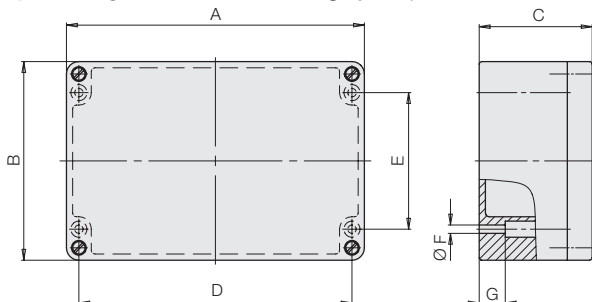

Volume [cm ³]	400	1,600	2,800
A [mm]	125	160	260
B [mm]	80	160	160
C [mm]	57	91	91
D [mm]	113	140	240
E [mm]	52	110	110
Ø F [mm]	4.3	6.3	6.3
G [mm]	10	21	21
Part no.	6350907	3141188	6355833

Calculation example for a clamping fixture with the elements below

Quantity	Element	Piston / bolt Ring-Ø [mm]	Stroke [mm]	Air volume per stroke [cm ³]
1	Block cylinder 1513000	25/16	8	2.3
2	Swing clamp 1885104	40	22	55.3
2	Threaded work support 1957002	50	20	78.5
Total				136.1

Selection of empty housing:

136.1 x factor 10 = **1,361 cm³**

suitable empty housing (1,600 cm³)

Part no. 3141188